











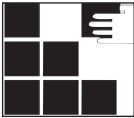







Xo1 Xo4 Xo6 110 volts UK

Original Operating Instructions

Electronic Hand-Mixer

© Collomix

	▲	WK 120 WK 140 WK 160			
	▲	MK 120 MK 140 MK 160			
	◀	KR 120 KR 140 KR 160			
	▼	LX 120			
	▼	DLX 120 DLX 152			

	Xo 1	Xo 4	Xo 6
WK 120	•	•	
WK 140		•	•
WK 160			•
MK 120	•	•	
MK 140		•	•
MK 160			•
KR 120	•	•	
KR 140		•	•
KR 160			•
LX 120	•	•	
DLX 120	•	•	
DLX 152		•	•

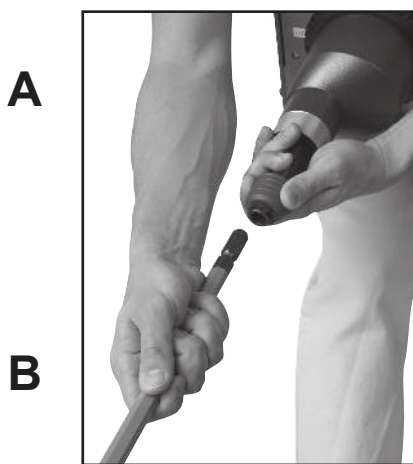
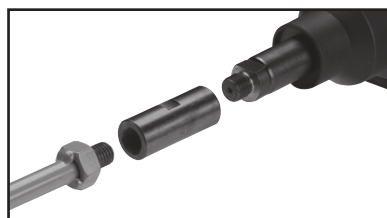
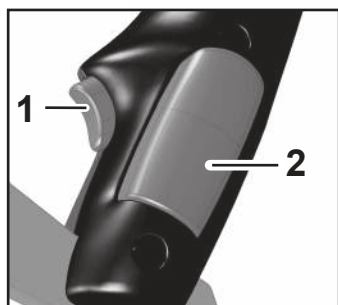
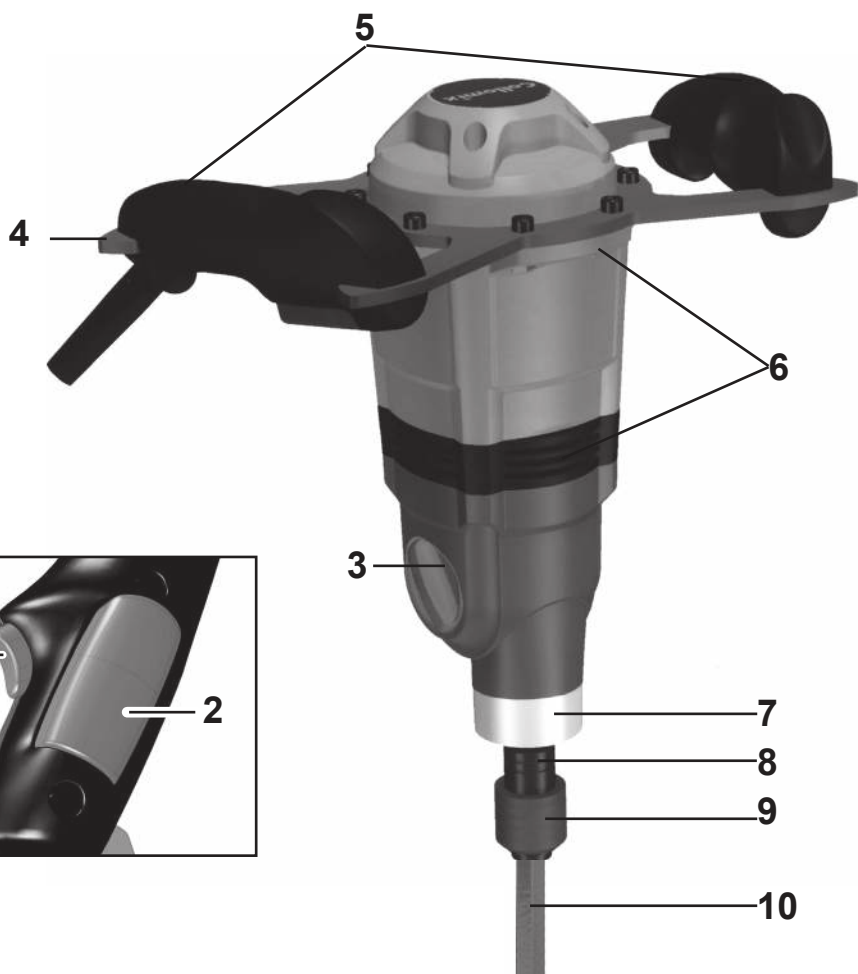

EN Technical data

	Xo 1	Xo 4	Xo 6
Rated power:	1010W	1300W	1600W
Power supply:	110-125 volts AC	110-125 volts AC	110-125 volts AC
Frequency:	50/60 hz	50/60 hz	50/60 hz
No-load speed, first gear	- 900 min ⁻¹	- 660 min ⁻¹	- 660 min ⁻¹
second gear		- 920 min ⁻¹	- 920 min ⁻¹
Rpm under load, first gear	- 650 min ⁻¹	- 450 min ⁻¹	- 410 min ⁻¹
second gear		- 620 min ⁻¹	- 580 min ⁻¹
Maximum mixing tool diameter:	120 mm	140 (150*) mm	„160 mm
Weight w/o mixing tool:	4,5 kg	5,4 kg	5,4 kg
Protection class:	□ / II	□ / II	□ / II

Machine components

- 1 Release button for ON/OFF switch
- 2 ON/OFF switch
- 3 Gear selection switch (for Xo 4/Xo 6 only)
- 4 Handle frame
- 5 Handles
- 6 Ventilation slits
- 7 Neck of the machine
- 8 Mixing shaft
- 9 HEXAFIX adapter / size M14 adapter
- 10 Mixing tool

Noise/vibration levels

Measured values determined in accordance with EN 60745. The A-weighted noise level of the machine is typically:

	Sound pressure level L_{pA} [dB(A)]	Sound power level L_{WA} [dB(A)]
Xo 1	82 dB(a)	93 dB(A)
Xo 4	88 dB(a)	99 dB(A)
Xo 6	88 dB(a)	99 dB(A)
	Uncertainty K = 3 dB	

Overall vibration level (for mixing of mineral materials)

	Emission level a_n [m/s ²]
Xo 1	2,0 m/s ²
Xo 4	2,2 m/s ²
Xo 6	2,2 m/s ²
	Uncertainty K = 1,5 m/s ²

WARNING:

The measured values which are provided apply to new machines. Noise and vibration levels change with day-to-day use.

NOTE

The vibration level given in these instructions was measured in accordance with a standardized method of measurement as defined in EN 60745 and can be used for the purposes of comparing electrical tools with each other. It is also suitable for a preliminary estimation of vibration strain. The vibration level which is given represents vibration level for the primary use of the electrical tool. If, however, the electrical tool is used for any other purposes, with different plug-in tools or with insufficient maintenance, the vibration level may vary. This can result in a significantly higher level of vibration strain over the work period as a whole.

For a precise estimation of the vibration strain the times when the machine is switched off have to be taken into account as well, as do the times when it is running but is not actually being used. This can result in a significantly reduced level of vibration strain over the work period as a whole.

CE Declaration of Conformity

We declare, with sole responsibility, that this product complies with the following standards or normative products: EN 50581:2013-02, EN 55014, EN 61000, EN 60745-1:2009 + EN60745-2-1:2010 in accordance with the provisions of directives 2014/30/EC, 2006/42 EC, 2011/65/EU.



Gaimersheim, 20.04.2016
Alexander Essing
Managing Director

Technical documentation can be requested from:

Collomix GmbH
Abt. Technische Entwicklung
Daimlerstr. 9, 85080 Gaimersheim, Germany

Machine-specific safety instructions

⚠ WARNING: Read all notes and instructions on safety. Failure to observe any of the notes and instructions on safety may result in an electric shock, fire and/or serious injury.

Make sure that you keep all notes and instructions on safety for future reference.

To be able to use the machine safely it is essential that you read the operating instructions and the safety instructions thoroughly and comply with all of them. The machine is to be used only by persons who have read the operating instructions and who are acquainted with the occupational safety and accident prevention regulations in force in your country.

⚠In addition, you must also comply with the general safety instructions also included with the machine.

► Take care to ensure that the mains power supply corresponds to the specifications on the rating plate.

► Do not use the device in any environments with potentially explosive atmospheres. Do not mix any readily flammable solvents or solvent-containing substances with a flash point of below 21° C / 69° F.

► Take care to ensure that no liquid splashes against the motor housing and keep it away from the rain – risk of electric shock!

► Never clean the machine with water – risk of electric shock!

► Do not wind cables or leads around any parts of your body.

► Do not use the machine with a damaged cable. Do not touch the cable and pull out the power plug immediately. There is an increased risk of electric shock from damaged cables. If the mains power cable has to be replaced (because of damage or similar), ensure that it is replaced by the manufacturer or an authorized representative of the manufacturer (electrician) in order to avoid any risk to safety.

► Always hold the machine firmly with both hands when carrying out your work and make sure you have a secure footing.

► Hold the machine by the insulated grip surfaces, when performing an operation where the plug-in tool may contact hidden wiring or it's own cord. Plug-in tools contacting a "live" wire may make exposed metal parts of the power tool "live"

and could give the operator an electric shock.

► Before starting up, check that the mixing rod is securely attached and rotates without a hitch.

► Start up and run down the machine in the mixing container only. Ensure that the mixing container is stood in a firm and secure position.

► Do not reach into the mixing container with your hands or insert any other objects into it while mixing is in progress. Risk of crushing!

► Wait until the machine or tool comes to a complete standstill. Rotating tools can snag and cause injuries or damage.

► If the sound pressure level should exceed 85 dB (A) where you are working, use ear protection!

► We recommend that you wear work gloves and protective goggles when using the mixer. Regulations require that you wear close-fitting clothing.

► To protect yourself from harmful dust while mixing, wear a dust mask. Some mineral materials are deemed to be carcinogenic. Use a dust extractor wherever possible. To select suitable dust extraction systems or dust masks please refer to the information of the material manufacturer's.

► Always connect machines via a residual current device (RCD) with a rated residual current of 30 mA or less.



Read and observe the operating instructions for the machine before you start it up!



Always wear protective goggles and ear protection while working.



It is advisable to wear a dust mask whenever working with materials which generate large amounts of dust.



Always wear protective gloves while working.

The machine is designed for mixing liquid and powder-based building products such as paints, mortar, adhesives, plaster and similar substances. Use the right mixing tool for the consistency of the material and the quantity to be mixed.

Please refer to the information in the technical data when choosing the size of mixing tool (diameter/mixing action). If the wrong mixing action or mixing tool diameter is selected, this may cause the machine/gear unit to become overloaded and lead to damage as a result. Please remember that a mixing tool with a mixing action from the top down puts a greater strain on the electrical tool than one with the reverse mixing action.

Given the high torque levels generated by the machine, it must not be used as a power drill.

The machine must not be used for the preparation of foodstuffs.

The machine is not suitable for mixing materials containing graphite dust, brine or slurry. Mixing of these materials or substances may damage the machine beyond repair.

Assembly

► Always pull the power plug out of the socket outlet before carrying out any work on the machine.

Fitting the mixing tool mount:

Take the HEXAFIX coupling or size M14 adapter supplied with the packaging and screw it to the male thread of the mixing shaft.

Fitting the mixing tool / tool change-over:

HEXAFIX (Fig. A)

Insert the mixing tool with the HEXAFIX mount in the coupling until it locks. To release or change the mixing tools, simply pull back the handle-collar on the coupling and this releases the mixing tool. (Fig. C)

M14 (Fig. B)

Screw the mixing tool with a size M14 male thread into the M14 adapter on the mixing shaft. The mixing tool tightens itself during operation.

To release the mixing tool you will need one SW 22 and one SW 24 open-ended wrench. Place the one open-ended wrench on the adapter and the other on the hexagonal holding fixture and turn them both in opposite directions to one another until the mixing tool is released.

Operation

► Check that the power supply shown on the rating plate is the same as the mains power supply.

Always hold the machine with both hands.

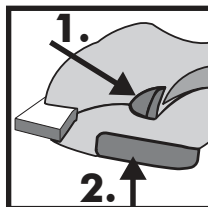

Press the starting lockout button (1).

Press the ON/OFF switch (2).

The more pressure you apply to the ON/OFF switch, the faster the machine will run. The ON/OFF switch cannot be locked!

Always work with the ON/OFF switch fully pressed.

To stop working, release the ON/OFF switch.

Machines with 2-speed gear units (Xo4/Xo6) have two maximum speeds available (First gear: Slow / Second gear: Fast).

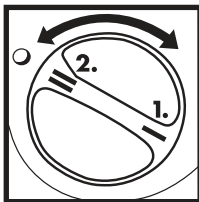

To change from one gear to the other, turn the gear selection lever through 180°.

Only ever actuate it when the machine is at a standstill.

! WARNING

Always reduce the speed when submerging the mixing tool in the mixing material or lifting it out. Once the mixing tool is fully submerged, increase the speed again to ensure that the motor is adequately cooled.

During mixing you should guide the machine around the mixing container. Continue mixing until all of the mixing material is completely mixed. Please follow the processing instructions of the manufacturer of the material.

The greater the viscosity of the material, the greater the impact of the torque forces on the machine, so you should be prepared for this when you carry out your work.

If the mixing tool comes into contact with a surface (e.g. the bottom of the tub) while running, it may kick back.

Set the machine down resting on the guard handle after you have finished your mixing work.

For transportation purposes the HEXAFIX mixing tool can be inserted through the hexagon punch-hole provided in the handle frame.

WARNING

► **Before you carry out any operations on the machine, and especially when changing the mixing tool, always pull out the power plug out first!**

Clean the machine and the mixing tool immediately after use. We recommend that you use the Collomix MIXER CLEAN cleaning bucket for cleaning.

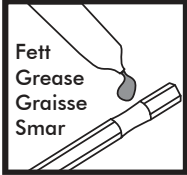

Keep the HEXAFIX coupling clean and freely moving at all times.

Take the mixing tool out of the coupling after you have finished your work.

Grease the hexagon mount of the **coupling at regular intervals with suitable grease.**

Keep the ventilation slits clean and clear at all times so that the machine can be properly cooled. Blocked ventilation slits will lead to irreparable damage to the machine.

Make sure that the ON/OFF switch moves and releases smoothly at all times.

The machine is equipped with self-deactivating carbon brushes. This means that the machine will shut itself down once a certain level of wear is reached. The carbon brushes can be replaced by the authorized customer service center or by the Collomix Service center.

Have repairs carried out only by an approved workshop or by your Collomix Service.

Only use original Collomix accessories and replacement parts.

For exploded drawings, lists of replacement parts and the form for repair orders, please refer to: <http://www.collomix.com>

Disposal

The device, accessories and packaging should all be consigned for environment-friendly recycling.

Electrical tools which have come to the end of their service lives must be made unusable by removing the mains power cable.

Do not dispose of electrical tools with household waste.

Content

1x Mixing machine
1x Mixing paddle
1x Hexafix adapter
1x Manual
1x General safety notes

Warranty

The manufacturer provides a warranty within the framework of his terms and conditions of delivery in accordance with the requirements of statutory/ country-specific provisions. Should you need to make a claim under the warranty, please provide us with your invoice or delivery note.

On no account will any warranty claims be accepted if any repairs are carried out by third parties. In the event of any irregularities, please send the machine to us. **Complaints can only be accepted if the device is sent to the Collomix Service center undismantled.**

The warranty does not apply to damages caused by normal wear, overloading, improper handling, unsuitable accessories or inadequate maintenance.

Any structural or functional modifications to the machine which are made without our agreement shall render the warranty and the Declaration of Conformity null and void.

Subject to change.

Manufacturer:
Collomix GmbH
Daimlerstrasse 9
85080 Gaimersheim
Germany

Collomix GmbH
Daimlerstraße 9
85080 Gaimersheim, Germany
info@collomix.de
www.collomix.com

